

Description

RKB is a range of straight flow in-line centrifugal duct fans designed for rectangular ducts. They are compact, high capacity fans which operate quietly and can be fitted in any position. RKB fans have backward curved impellers and are designed to cope with high pressure and long duct. The fans have a rigid housing made from galvanised steel. They are moisture proof and approved for use in outdoor environments. The motors are maintenance free and protected from overheating by thermo contacts. The impellers only require occasional cleaning. This cleaning is made easy with the RKB's swing out design. All fans are supplied fully wired and ready to fit in a sealed installation unit. The fans are not intended for transporting grinding dust, soot or similar. RKB fans come in 25 sizes.



Technical data

Parameter	Value	Unit
Voltage	230	V
Phase	1	~
Frequency	50	Hz
Power	0.13	kW
Current	0.59	A
R.p.m.	21	r/s
Max. temperature of transported air	70	°C
Max. temperature of transported air when speed-controlled	70	°C
Sound pressure level at 3 m	48	dB(A)
Length	532	mm
Width	542	mm
Height	294	mm
Weight	10	kg
Enclosure class, motor	44	IP
Insulation class, motor	F	
Capacitor	5	µF
Duct connection	500x250 mm	

Diagrams

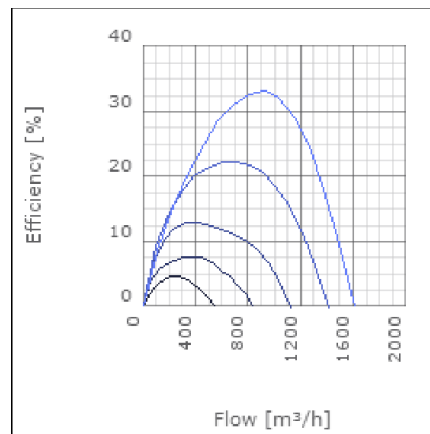
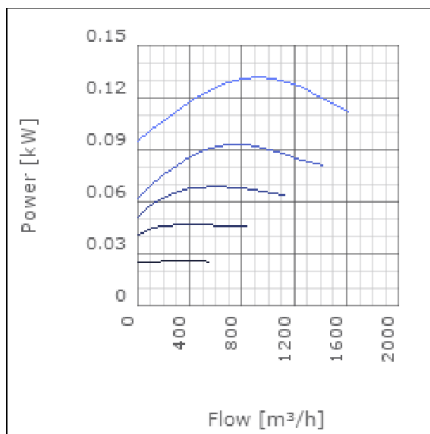
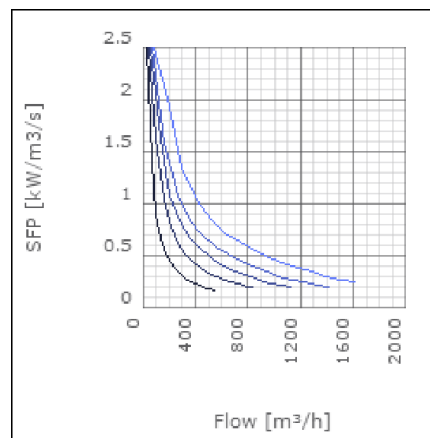
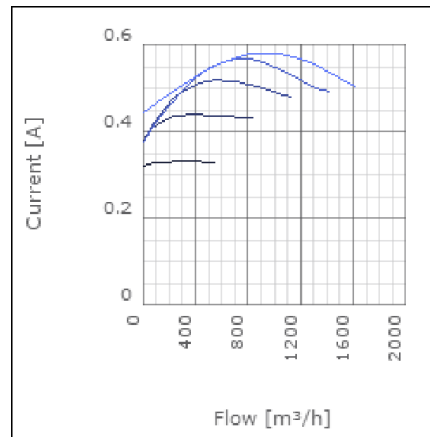
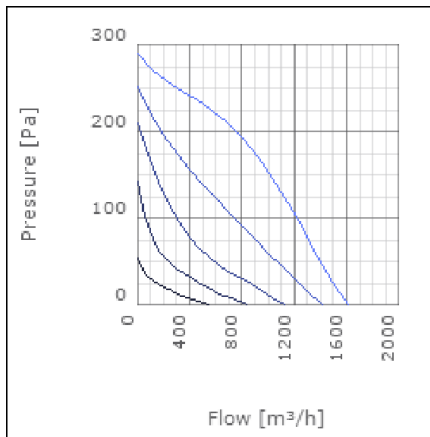

Sound

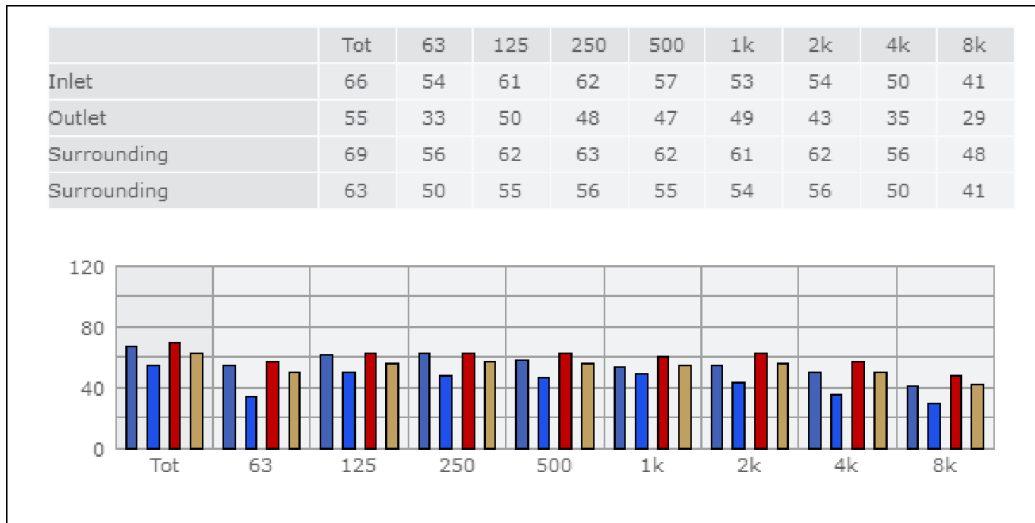

Parameter

Distance: 3.000
 Propagation type: Hemi-spherical
 Equivalent absorption area: 20.00

Checked point

Flow 967.626m³/h
 Static pressure 161Pa

Working point

Flow 969.035m³/h
 Static Pressure 161Pa
 Power 0.13kW
 Speed 0r/s
 Current 0.58A
 Voltage 230V
 Efficiency 32.87%
 SFP 0kW/m³/s

Dimensions

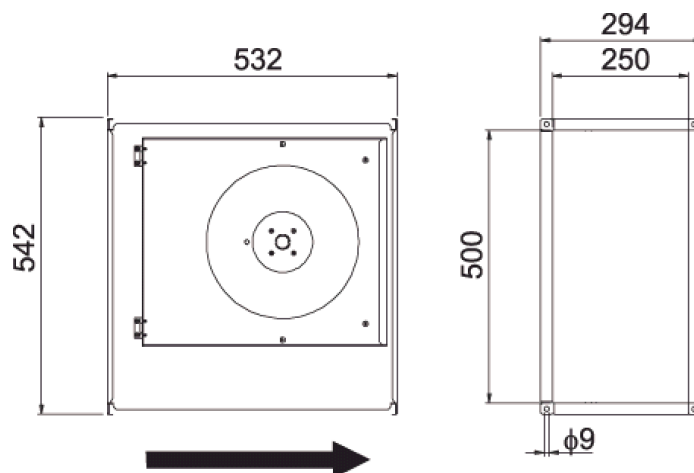

Wiring diagram

4040001

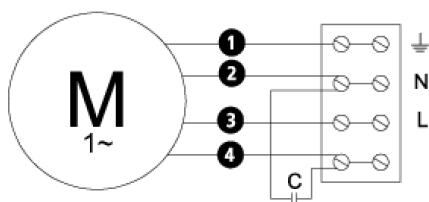

- Ⓜ = Fan Motor
- Ⓜ1 = Fan Motor
- Ⓜ2 = Fan Motor
- Ⓜ3 = Rotor Motor
- ① = Yellow/Green
- ② = Black
- ③ = Blue
- ④ = Brown
- ⑤ = White (TW)
- ⑥ = Orange
- ⑦ = Grey
- ⑧ = Red
- ⑨ = Green
- ⑩ = Violet

Accessories

ETFV-94A
FRE 6
VRDE 1,5
VRS 1,0
VRTEC

Electrical accessories

FLR 500x250
DS 500x250
LDR 500x250